

**Anritsu**

**Site Master™**  
**S112, S113**  
**Personal SWR/RL and**  
**Fault Location Tester**

---

*User's Guide*



**Hand-Held Tester For Antennas, Transmission Lines  
And Other RF Components**

### **WARRANTY**

The ANRITSU product(s) listed on the title page is (are) warranted against defects in materials and workmanship for one year from the date of shipment.

ANRITSU's obligation covers repairing or replacing products which prove to be defective during the warranty period. Buyers shall prepay transportation charges for equipment returned to ANRITSU for warranty repairs. Obligation is limited to the original purchaser. ANRITSU is not liable for consequential damages.

### **LIMITATION OF WARRANTY**

The foregoing warranty does not apply to ANRITSU connectors that have failed due to normal wear. Also, the warranty does not apply to defects resulting from improper or inadequate maintenance by the Buyer, unauthorized modification or misuse, or operation outside the environmental specifications of the product. No other warranty is expressed or implied, and the remedies provided herein are the Buyer's sole and exclusive remedies.

### **TRADEMARK ACKNOWLEDGEMENTS**

MS-DOS, Windows, and Windows for Workgroups are registered trademarks of the Microsoft Corporation.

**Site Master, Site Master 110, Site Master S110, Site Master S111, Site Master S112, Site Master S113, Site Master 330, Site Master S330, and Site Master S331** are trademarks of ANRITSU Company.

### **NOTICE**

ANRITSU Company has prepared this manual for use by ANRITSU Company personnel and customers as a guide for the proper installation, operation and maintenance of ANRITSU Company equipment and computer programs. The drawings, specifications, and information contained herein are the property of ANRITSU Company, and any unauthorized use or disclosure of these drawings, specifications, and information is prohibited; they shall not be reproduced, copied, or used in whole or in part as the basis for manufacture or sale of the equipment or software programs without the prior written consent of ANRITSU Company.

## DECLARATION OF CONFORMITY

**Manufacturer's Name:** ANRITSU COMPANY

**Manufacturer's Address:** Microwave Measurements Division  
490 Jarvis Drive  
Morgan Hill, CA 95037-2809  
USA

declares that the product specified below:

**Product Name:** Site Master

**Model Number:** S110, S111, S112, S113, S330, S331

conforms to the requirement of:

EMC Directive 89/336/EEC as amended by Council Directive 92/31/EEC & 93/68/EEC  
Low Voltage Directive 73/23/EEC as amended by Council directive 93/68/EEC

### **Electromagnetic Interference:**

Emissions: CISPR 11:1990/EN55011:1991 Group 1 Class A

Immunity: IEC 1000-4-2:1995/prEN50082-1:1995 - 4kV CD, 8kV AD  
IEC 1000-4-3:1993/ENV50140:1994 - 3V/m  
IEC 1000-4-4:1995/prEN50082-1:1995 - 0.5kV SL, 1kV PL

### **Electrical Safety Requirement:**

Product Safety: The Product Complies when used with Company supplied Power  
Supply (tested to EN 60950)

Morgan Hill, CA

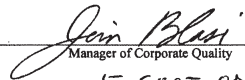
  
Manager of Corporate Quality

5-SEPT-97  
Date

European Contact: For Anritsu product EMC & LVD information, contact Anritsu LTD, Rutherford Close,  
Stevenage Herts, SG1 2EF UK, (FAX 44-1438-740202)

# *Table of Contents*

---

<b>General Information . . . . .</b>	<b>1-1</b>
<b>Introduction. . . . .</b>	<b>1-1</b>
<b>Description . . . . .</b>	<b>1-1</b>
<b>Standard Accessories . . . . .</b>	<b>1-2</b>
<b>Options . . . . .</b>	<b>1-3</b>
<b>Optional Accessories . . . . .</b>	<b>1-3</b>
<b>Spares . . . . .</b>	<b>1-4</b>
<b>Performance Specifications . . . . .</b>	<b>1-5</b>
<b>Operation . . . . .</b>	<b>2-1</b>
<b>Introduction. . . . .</b>	<b>2-1</b>
<b>Control Descriptions . . . . .</b>	<b>2-1</b>
Test Panel. . . . .	2-1
Keypad . . . . .	2-2
Soft Keys . . . . .	2-6
Remote Operation. . . . .	2-20
<b>Operating Procedures. . . . .</b>	<b>2-20</b>
<b>Making Common Function Selections . . . . .</b>	<b>2-21</b>
Applying Power . . . . .	2-21
Setting Options . . . . .	2-22
Setting Scale/Limits . . . . .	2-22
Determining Remaining Battery Life . . . . .	2-23
<b>Making Frequency-Domain Measurements</b>	<b>2-24</b>
<b>Return Loss or SWR Measurement . . . . .</b>	<b>2-24</b>
Selecting a Frequency Range. . . . .	2-24
Performing a Calibration. . . . .	2-24
Making a Measurement . . . . .	2-26
Scaling the Display . . . . .	2-27

Adjusting Markers . . . . .	2-27
Adjusting a Limit . . . . .	2-28
Saving a Setup . . . . .	2-28
Recalling a Setup . . . . .	2-28
Storing a Display . . . . .	2-29
Recalling a Display . . . . .	2-29
<b>Cable Loss Measurement . . . . .</b>	<b>2-30</b>
Selecting a Frequency Range . . . . .	2-30
Performing a Calibration . . . . .	2-30
Making a Measurement . . . . .	2-32
Scaling the Display . . . . .	2-32
Adjusting Markers . . . . .	2-32
Adjusting a Limit . . . . .	2-33
Saving a Setup . . . . .	2-33
Recalling a Setup . . . . .	2-34
Storing a Display . . . . .	2-34
Recalling a Display . . . . .	2-34
<b>Making Distance-Domain Measurements . . . . .</b>	<b>2-35</b>
Selecting a Frequency Range . . . . .	2-35
Performing a Calibration . . . . .	2-37
Performing a DTF Measurement . . . . .	2-38
<b>Making Power Measurements . . . . .</b>	<b>2-40</b>
Entering Power Monitor Mode . . . . .	2-40
Zeroing the Power Monitor . . . . .	2-40
Measuring High Input Power Levels . . . . .	2-41
Displaying Power in dBm and Watts . . . . .	2-41
Displaying Relative Power . . . . .	2-41
<b>Printing. . . . .</b>	<b>2-42</b>
Printer Switch Settings . . . . .	2-42
Printing a Screen . . . . .	2-43
<b>Symbols . . . . .</b>	<b>2-44</b>
<b>Self Test . . . . .</b>	<b>2-44</b>
<b>Error Codes . . . . .</b>	<b>2-44</b>
Self Test Errors . . . . .	2-44
Range Errors . . . . .	2-44

Replacing the Battery . . . . .	2-44
Using the Soft Carrying Case. . . . .	2-49
<b>Software Tools Program . . . . .</b>	<b>3-1</b>
Description . . . . .	3-1
Requirements . . . . .	3-1
<b>Communication Port Setting. . . . .</b>	<b>3-2</b>
Changing COM Port Settings–Windows 3.1 . . . . .	3-2
Changing COM Port Settings–Windows 95 . . . . .	3-4
<b>Software Installation . . . . .</b>	<b>3-6</b>
<b>Plot Capture. . . . .</b>	<b>3-7</b>
Multiple trace capture (preferred method). . . . .	3-7
Single trace capture . . . . .	3-9
<b>Program Operation . . . . .</b>	<b>3-10</b>
<b>Fault Location Software . . . . .</b>	<b>3-11</b>
<b>Smith Chart Software. . . . .</b>	<b>3-11</b>
Saving a Plot as a Windows Metafile. . . . .	3-12
Saving Data to a Spreadsheet. . . . .	3-12
“Drag-n-Drop” . . . . .	3-13
Printing. . . . .	3-13

## How to Use this Manual

The operation of the **Site Master**™ is straightforward and intuitive. However, you may find it helpful to review the operation of the keys and menus prior to first-time use.

Descriptions of the keys and menus, along with measurement procedures, are provided in Chapter 2.

First-time users and maintenance supervisors will benefit from perusing the material in Chapter 1. This chapter describes the instrument and provides listings of options and performance specifications.

---

### Please Recycle

This product contains a rechargeable battery. This battery may be recyclable. For environmental reasons, you should dispose of the battery in a proper manner at the end of equipment life. If you do not have access to proper disposal methods, return the battery to your ANRITSU service center.

ANRITSU will dispose of the unit at no charge. ANRITSU service centers are listed in Table 2-4 (page 2-50).



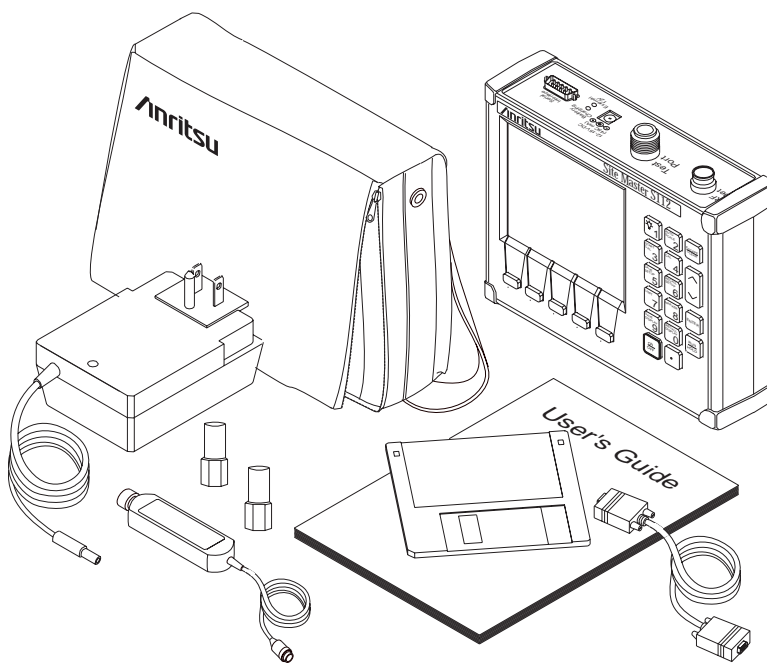

---

Figure 1-1. Site Master System

**1 - 0**



# Chapter 1

## General Information



### Introduction

This chapter provides description, specification, and optional accessories for the **Site Master** Series instruments. This series has two members, as shown below. Throughout this manual, the term **Site Master** will refer to the series; whereas, the terms **Site Master S112, S113** will refer to the applicable individual models.

<b>Model</b>	<b>Frequency Range</b>
S112	5 to 1000 MHz
S113	5 to 1200 MHz

### Description

The **Site Master** (Figure 1-1) is a hand held SWR/RL(standing wave ratio/return loss) and Distance-To-Fault measurement instrument that includes a built-in synthesized signal source and an optional power monitor. It uses a keypad to enter data and a liquid crystal display (LCD) to provide a graphical indication of SWR or RL over the selected frequency range. The **Site Master S113** has a built-in distance-to-fault capability. The **Site Master S112**, as well as model **S113**, allows measurement data to be converted to Fault Location via the companion Software Tools program. The **Site Master** is capable of up to two hours of continuous operation from a fully charged internal battery. It can also be operated from a 12.5 dc source (which will also simulta-

## *Chapter 1 General Information*

---

neously charge the battery). Built-in energy conservation features can be used to extend battery life over an eight-hour work day.

The **Site Master** is designed for measuring SWR, return loss, or cable insertion loss and locating faulty RF components in antenna systems. Power monitoring capability is available as an option. The displayed trace can be scaled and/or enhanced with settable frequency markers and/or a limit line. A menu option provides for an audible “beep” when the limit value is exceeded. To permit use in low-light environments, the LCD can be back lit using a front panel key.

## **Standard Accessories**

A PC based software program (called Software Tools) provides an on-line database record for storing measurement data. **Site Master** Software Tools can also convert the **Site Master** display to a Microsoft Windows 3.x graphic. Measurements stored in the **Site Master** internal memory are down-loaded to the PC using the included serial cable. This null-modem serial cable connects between the Serial Interface connector on the **Site Master** and a Com Port on a DOS/Windows-based PC. Once stored, the graphic trace can then be displayed, scaled, and/or enhanced with markers and limit lines. Historical graphs can be overlaid with current data by using the PC’s mouse in “drag-n-drop” fashion. The underlying data can be extracted and used in spreadsheets or for other analytical tasks.

The Software Tools program also performs DTF (Distance To Fault) or Fault Location by clicking on the appropriate icon.

The following items are supplied with the basic hardware.

- Soft carrying case
- Standard Calibration Components
- AC-DC adapter
- Automotive Cigarette Lighter 12 Volt DC Adapter
- 3 1/2-inch floppy disk containing the Software Tools program. This program contains Fault Location (DTF) and Smith Chart functions.
- Serial Interface Cable, Part Number 800-441
- One year Warranty (includes battery, firmware, and software)
- User's Guide
- Programming Manual



## Options

- Option 1 — Switch Standard Calibration Components to Precision N type components
- Option 5 — Add RF Wattmeter Power Monitor

## Optional Accessories

- ANRITSU precision N type Short/Open, Part No. 22N50
- Site Master precision N Load, 42 dB Part No. SM/PL
- Test Port Extension Cable, 1.5 meter, Part No. TP/ECN 1.5
- Test Port Extension Cable, 3.0 meter, Part No. TP/ECN 3.0

## ***Chapter 1 General Information***

---

- Test Port Extension Cable, 5.0 meter, Part No. TP/ECN 5.0
- Test Port Extension Cable, 1.5 meter, Part No. TP/EC 1.5
- Test Port Extension Cable, 3.0 meter, Part No. TP/EC 3.0
- Test Port Extension Cable, 5.0 meter, Part No. TP/EC 5.0
- RF Detector, 1 to 3000 MHz, N(m) input connector, 50 Ohms, Part No. 5400-71N50
- Transit Case for Site Master, Part No. 760-194A
- HP Deskjet 340 Printer, Part No. 2000-766
- Serial-to-Parallel Converter Cable (use with the HP 340 Printer), Part No. 2000-753
- Seiko DPU-411 Thermal Printer, Part No. 2000-754 or 2000-761
- Serial Interface Cable (use with the DPU-411 Printer), Part No. 2000-756
- Thermal Paper (use with the DPU-411 Printer), Part No. 2000-755

## **Spares**

- N type Standard Short, Part No. SM/STS
- N type Standard Load, 35 dB, Part No. SM/STL
- Soft Carrying Case, Part No. D41955
- AC/DC Adapter, Part No. 40-97
- Serial Interface Cable, Part Number 800-441

## Performance Specifications

Performance specifications are provided in Table 1-1.

*Table 1-1. Performance Specifications (1 of 2)*

*Specifications are valid when the unit is calibrated at ambient temperature after a 5 minute warmup.*

<b>Description</b>	<b>Value</b>
Frequency Range:	
<b>Site Master S112</b>	5 to 1000 MHz
<b>Site Master S113</b>	5 to 1200 MHz
Frequency Accuracy (CW Mode)	75 parts per million @25°C*
Frequency Resolution	10 kHz
SWR:	
Range	1.00 to 65.00
Resolution	0.01
Return Loss:	
Range	0.0 to 54.00 dB
Resolution	0.01 dB
Cable Insertion Loss:	
Range	0.0 to 20.00 dB
Resolution	0.01 dB
**Distance-To-Fault (DTF):	
Range	0 to (Resoution x 129)
Resolution (in meters)	$(15 \times 10^3)(V_p)$
(Rectangular Windowing)	$\frac{\Delta Frequency}{V_p}$
	Where $V_p$ is the cable's relative propagation velocity.

## Chapter 1 General Information

---

Table 1-1. Performance Specifications (2 of 2)

---

Wattmeter Power Monitor:	
Range	-50.0 to +20 dBm <i>or</i> 10.0 nW to 100.0 mW
Offset Range	0 to +60.0 dB
Resolution	0.1 dB <i>or</i> 0.1 xW
Test Port, Type N	50 Ohms
***Immunity to Interfering signals up to the level of	+10 dBm
Maximum Input (Damage Level):	
Test Port, Type N	+22 dBm
RF Detector	+20 dBm

### Measurement Accuracy:

Measurement accuracy depends on calibration components. Standard calibration components have a directivity of 35 dB. Precision calibration components have a directivity of 42 dB.

### Temperature:

Storage	-20° C to 75° C
Operation	0° C to 50° C

Weight: 2.2 pounds

Size: 8x7x2¼ inches

---

\* ±2 ppm/Δ°C from 25°C

\*\* Fault location is accomplished by inverse Fourier Transformation of data taken with the *Site Master*. Resolution and maximum range depend on the number of frequency data points, frequency sweep range and relative propagation velocity of the cable being tested.

\*\*\* Immunity measurement is made in CW mode with incoming interfering signal exactly at the same frequency (worst case situation). Typical immunity is better when swept frequency is used.

---



This page is intentionally blank

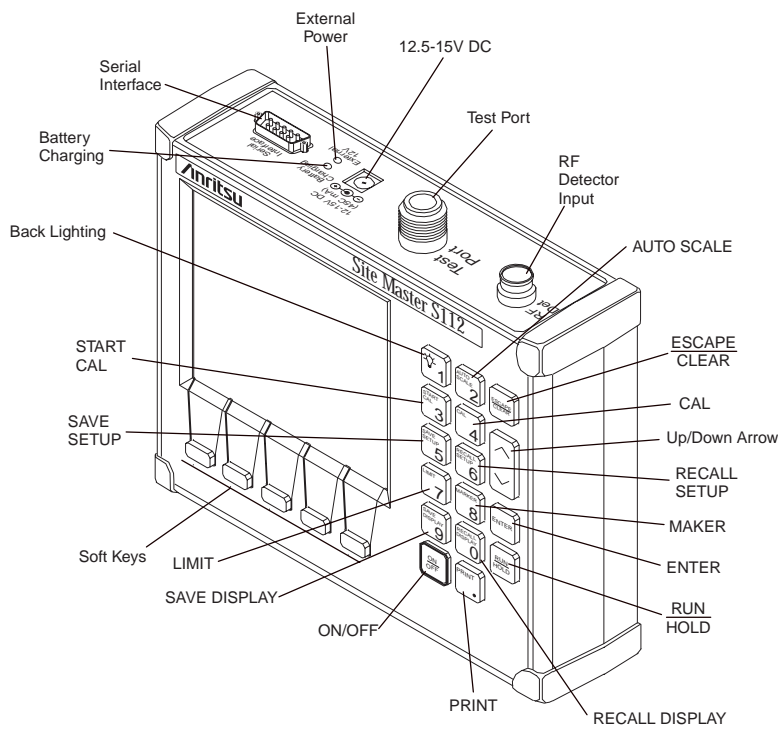

Figure 2-1. *Site Master Controls and Connectors*

**2 - 0**



# Chapter 2

## Operation

### Introduction

This chapter provides a description of each control and describes how to calibrate the **Site Master** and make a measurement.

### Control Descriptions

Control descriptions are given below; the test panel controls and connectors are listed first. The keypad controls follow and are listed alphabetically. Then, the soft keys and menu structure are described using Figure 2-3 (page 2-7).



#### Test Panel

- |                            |  |
|----------------------------|--|
| <b>12.5-15VDC (600 mA)</b> | Provides input for battery charging the unit. Input is 12.5 to 15 Vdc @ 600 mA.  |
| <b>Battery Charging</b>    | Indicator light to show that the battery is being charged.   |
| <b>External Power</b>      | Indicator light to show that the <b>Site Master</b> is being powered by the external charging unit.  |
| <b>Serial Interface</b>    | Provides an RS232 DB9 interface with a Com Port on a personal computer (for use with the ANRITSU Software Tools program). Also provides an interface |

## Chapter 2 Operation

---

to a HP Deskjet 340 printer or a Seiko DPU-411 Thermal printer.

### **Test Port**

Provides RF output, 50Ω impedance.

### **RF Det**

Provides RF detector input for the Power Monitor.

## Keypad



Turns the liquid crystal display (LCD) back-lighting ON or OFF. (Leaving back lighting off conserves battery power.)

### **AUTO SCALE**

Automatically scales the display for optimum resolution.

### **CAL**

Opens a calibration menu. Use Up/Down Arrow key and ENTER key to select a stored calibration (A or B) or turn CAL off.

### **ENTER**

Implements certain menu and key selections.

### **ESCAPE CLEAR**

Exits the present operation and/or clears the display. If a parameter is being edited, pressing this key will clear the value currently being entered and restore the last valid entry. Pressing this key again will close the parameter. During normal sweeping, pressing this key will move up one menu level.

### **LIMIT**

Calls up the Scale Menu.

### **MARKER**

Calls up the Marker Menu.

### **ON OFF**

Turns the **Site Master** on or off. When turned on, the system state at the last turn-off is restored. If the

ESCAPE key is held down, the factory preset state is restored.

- PRINT** Prints the current display to the selected printer.
- RECALL DISPLAY** Recalls a previously saved trace from memory location 1 through 40. When the key is pressed, "Recall display:" appears on the display. Select an appropriate number from the keypad and press the ENTER key to implement.
- RECALL SETUP** Recalls a previously saved setup from memory location 0 through 9. When the key is pressed, "Recall Setup:" appears on the display. Select an appropriate number from the keypad and press the ENTER key to implement. Setup 0 recalls the factory preset state.
- RUN HOLD** When in the Hold mode, this key starts the **Site Master** sweeping and provides a Single Sweep Mode trigger; when in the Run mode, it pauses the sweep. When in the Hold mode, the hold symbol (Table 2-1, page 2-45) appears on the left side of the LCD. (HOLD conserves considerable battery power.)
- SAVE DISPLAY** Saves the displayed trace to 1 of 40 internal non-volatile memory locations. When the key is pressed, "Save display:" appears on the display. Select an appropriate number from the keypad and press the ENTER key to implement.

**CAUTION:** *The selected memory location will be overwritten by the SAVE DISPLAY operation. No warning is given.*

**SAVE  
SETUP** Saves the current system setup to 1 of 9 internal non-volatile memory locations. When the key is pressed, "Save Setup:" appears on the display. Select an appropriate number from the keypad and press the ENTER key to implement.

**CAUTION:***The selected memory location will be overwritten by the SAVE SETUP operation. No warning is given.*



**START  
CAL** Opens a calibration menu. Use the Up/Down Arrow key and ENTER key to select the location to store the calibration (A or B) or cancel the command. The existing calibration in the location chosen will be overwritten once the calibration is performed.

Follow the text in the message area that instructs you to do the following:

- ❑ **Connect OPEN, Press ENTER**  
The **Site Master** then measures the "open" test port (standard calibration), or the calibration "open" (precision calibration kit) that you must attach to the end of the test port or transmission line.
- ❑ **Connect SHORT, Press ENTER**  
The **Site Master** then measures the calibration "short" that you must attach to the end of the test port or transmission line.

- Connect LOAD, Press ENTER

The **Site Master** then measures the 50Ω termination (load) that you must attach to the end of the test port or transmission line.

**NOTES:**

*The order of the "Open," "Short," and "Load" measurements can be changed or the selection repeated using the Up/Down Arrow Key.*

*The combined measurements of an open, a short, and a known-impedance load normalizes the measurement system, to account for uncertainties introduced by measurement-system components (e.g., cables, connectors, etc.).*

**Up/Down Arrow Key** Increments or decrements a parameter value.



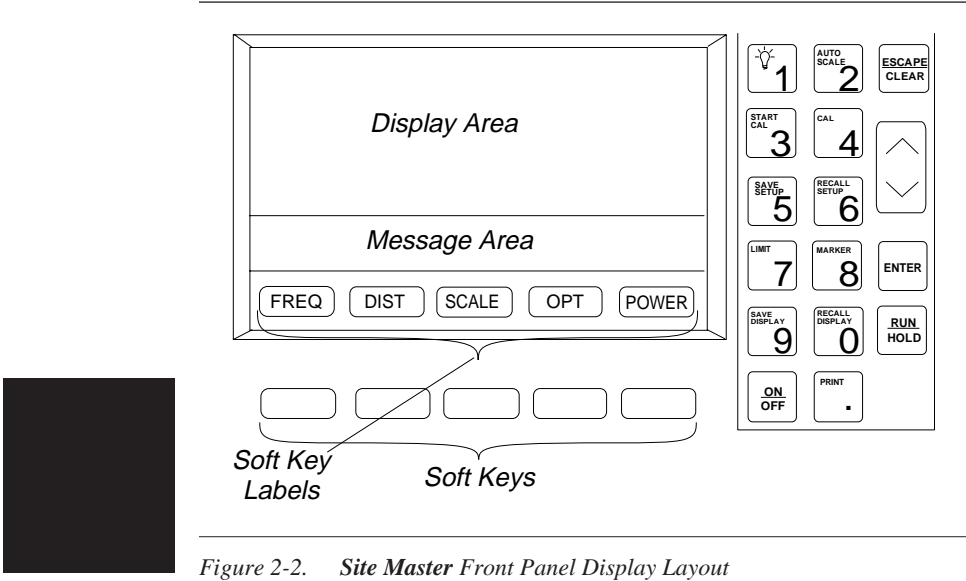
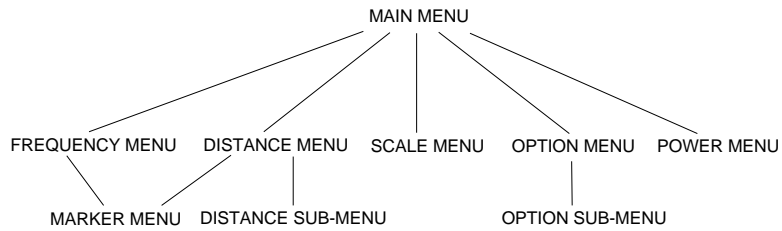

Figure 2-2. Site Master Front Panel Display Layout

### Soft Keys

Each of the soft keys has a corresponding soft key label area on the display. The label identifies the function of the soft key for the current menu selection. Figure 2-3, on the following page, shows the menu structure, the soft key labels for each menu selection, and the page where a description of the menu can be found.



MENU TITLE	SOFT KEY LABELS	PAGE
MAIN MENU	FREQ DIST SCALE OPT POWER	2-8
FREQUENCY MENU	F1 F2 MKRS [ ] MAIN	2-9
DISTANCE MENU	D1 D2 MKRS [ ] MORE	2-11
DISTANCE SUB-MENU	LOSS PROP V CABLE WINDW MAIN	2-12
MARKER MENU	M1 M2 M1PEAK M2PEAK MAIN	2-10
SCALE MENU	TOP BOTTOM LIMIT [ ] MAIN	2-16
OPTION MENU	B1 B2 B3 B4 MORE	2-17
OPTION SUB-MENU	B5 B6 B7 B8 MAIN	2-18
POWER MENU	UNITS REL OFFSET ZERO MAIN	2-19

Figure 2-3. Site Master Menu Structure

## Chapter 2 Operation

---

**Main Menu** At turn on, the Main Menu soft keys, below, are displayed, and the Marker status is shown in the message area.



These soft keys provide the following menu selections:

- ❑ **FREQ** — Selects the Frequency Menu, described on page 2-9.
- ❑ **DIST** — Selects the Distance Menu, described on page 2-11.
- ❑ **SCALE** — Selects the Scale Menu, described on page 2-16.
- ❑ **OPT** — Selects the Option Menu, described on page 2-17.
- ❑ **POWER** — Selects the Power Menu, described on page 2-19.





**Frequency Menu (FREQ)** Provides for setting sweep frequency end-points. Also provides access to the Marker Menu. Selected frequency values may be changed using the keypad or Up/Down Arrow key.

Choosing FREQ causes the soft keys, below, to be displayed and the corresponding values to be shown in the message area.



- ❑ F1 — Opens the F1 parameter for data entry. This is the start value for the frequency sweep. Press ENTER when data entry is complete.
- ❑ F2 — Opens the F2 parameter for data entry. This is the stop value for the frequency sweep. Press ENTER when data entry is complete.
- ❑ MKRS — Selects the Markers Menu, described on page 2-10.
- ❑ MAIN — Returns to the Main Menu.



## Chapter 2 Operation

---

### Marker Menu (MKRS)

Provides for setting marker values. Selected frequency or distance values may be changed using the keypad or Up/Down Arrow key.

Choosing MKRS causes the soft keys, below, to be displayed and the corresponding values to be shown in the message area.

Pressing the MARKER key will also call up this menu.

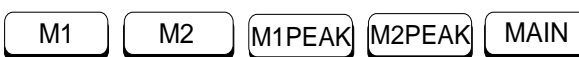

- ❑ M1 — Turns M1 marker OFF, if it is currently ON. If M1 is currently OFF, turns it ON and opens the M1 marker parameter for data entry, displaying either frequency or distance and the corresponding SWR, RL, or CL. Press ENTER when data entry is complete.
- ❑ M2 — Turns M2 marker OFF, if it is currently ON. If M2 is currently OFF, turns it ON and opens the M2 marker parameter for data entry, displaying either frequency or distance and the corresponding SWR, RL, or CL. Press ENTER when data entry is complete.
- ❑ M1PEAK — Places the M1 marker at the frequency or distance with the peak SWR, RL, or CL value.
- ❑ M2PEAK — Places the M2 marker at the frequency or distance with the peak SWR, RL, or CL value.

- MAIN — Returns to the Main Menu.

**Distance  
Menu  
(DIST)**

Provides for setting Distance to Fault parameters. Selected distance values may be changed using the keypad or Up/Down Arrow key. Entry can be in feet or meters, depending on the setting of the B5 soft key in the Option Sub-Menu (page 2-18).

Choosing DIST causes the soft keys, below, to be



displayed and the corresponding values to be shown in the message area.

- D1 — Opens the start distance (D1) parameter for data entry. This is the start value for the distance range. Press ENTER when data entry is complete.
- D2 — Opens the end distance (D2) parameter for data entry. This is the end value for the distance range. Press ENTER when data entry is complete.
- MKRS — Selects the Marker Menu, described on page 2-10.
- MORE — Selects the Distance Sub-Menu, described on page 2-12.



## Chapter 2 Operation

---

*NOTE: Refer to the table on the inside of the manual back cover for a listing of common coaxial cables showing values for "Dielectric," "Relative Velocity," "Dielectric Constant," and "Nominal Attenuation in dB/m @ 1000 MHz".*

**Distance Sub-Menu** Provides for setting the cable loss and relative propagation velocity of the coaxial cable. Selected values may be changed using the keypad or Up/Down Arrow key.

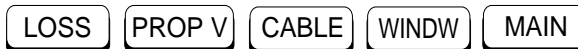

Choosing MORE causes the soft keys, below, to be displayed and the corresponding values to be shown in the message area.

- ❑ LOSS — Opens the Cable Loss parameter for data entry. Enter the loss per foot (or meter) for the type of transmission line being tested. Press ENTER when data entry is complete. (Range is 0.000 to 5.000 dB/m)
- ❑ PROP V (relative propagation velocity) — Opens the Propagation Velocity parameter for data entry. Enter the propagation velocity for the type of transmission line being tested. Press ENTER when data entry is complete. (Range is 0.010 to 1.000)
- ❑ CABLE — Opens a menu of common coaxial cables. Use the up/down arrow key and ENTER key

to make a selection. This feature is provided as a rapid means of setting both cable loss and propagation velocity.

- ❑ WINDW — Opens a menu of FFT windowing types for the DTF calculation. Use the Up/Down Arrow key and ENTER key to make a selection.

*NOTE: Using Windowing*

*The theoretical requirement for inverse FFT is for the data to extend from zero frequency to infinity. Side lobes appear around a discontinuity due to the fact that the spectrum is cut off at a finite frequency. Windowing reduces the side lobes by smoothing out the sharp transitions at the beginning and end of the frequency sweep. As the side lobes are reduced the main lobe widens thereby reducing the resolution.*

*In situations where there may be a small discontinuity close to a large one, side lobe reduction Windowing should be used. When distance resolution is critical Windowing can be reduced. The types of Windowing in order of increasing side lobe reduction are: rectangular, nominal side lobe, low side lobe, minimum side lobe. Figures 2-4 thru 2-7, on pages 2-14 and 2-15, are examples of the types of Windowing.*

- ❑ MAIN — Returns to the Main Menu.

**Chapter 2 Operation**

---

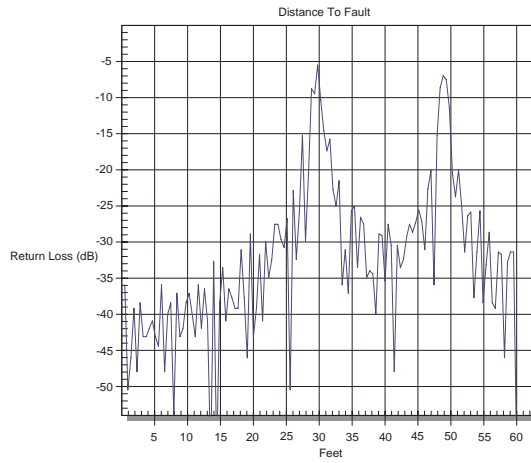

*Figure 2-4. Rectangular Windowing Example*

---

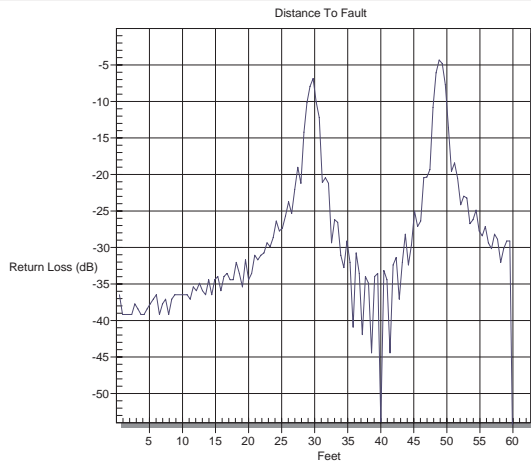

*Figure 2-5. Nominal Side Lobe Windowing Example*

---

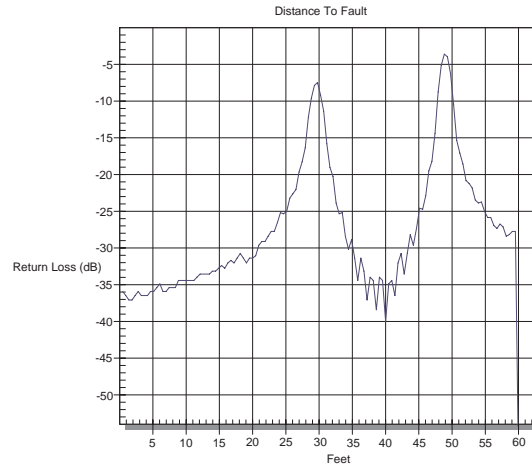

Figure 2-6. Low Side Lobe Windowing Example

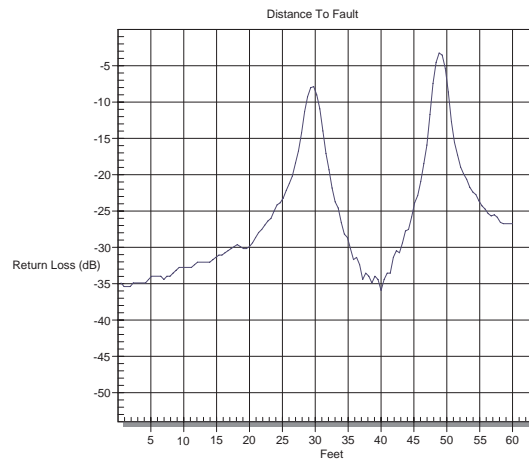

Figure 2-7. Minimum Side Lobe Windowing Example

**Scale Menu (SCALE)** Provides for changing the display scale. Selected values may be changed using the keypad or Up/Down Arrow key.

Choosing **SCALE** causes the soft keys, below, to be displayed and the corresponding values to be shown in the message area.

Pressing the **LIMIT** key on the keypad will also call up this menu.



- ❑ **TOP** — Opens the **TOP** parameter for data entry and provides for setting the top scale value. Press **ENTER** when data entry is complete.
- ❑ **BOTTOM** — Opens the **BOTTOM** parameter for data entry and provides for setting the bottom scale value. Press **ENTER** when data entry is complete.
- ❑ **LIMIT** — Turns Limit OFF, if currently ON. If Limit is currently OFF, turns it ON and opens the Limit parameter for data entry. Press **ENTER** when data entry is complete.
- ❑ **MAIN** — Returns to the Main Menu.



**Option  
Menu  
(OPT)**

Provides for selecting **Site Master** options.

Choosing OPT causes the soft keys, below, to be displayed and the corresponding values to be shown in the message area.

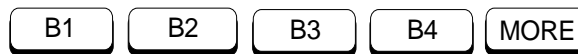

- ❑ B1 MODE — Opens a menu of measurement modes; Return Loss (RL), Standing Wave Ratio (SWR), and Cable Loss(CL). Use the Up/Down Arrow key and ENTER key to make a selection.
- ❑ B2 LIMIT BEEP ON/OFF — Toggles the limit beeping sound on or off. When on, the **Site Master** sounds a beep when the measured value is above the limit line.
- ❑ B3 KEYBD LOCK ON/OFF — Toggles the keyboard locking feature on or off. When on, the keyboard (except for the keys listed below) is locked to prevent inadvertant data entry.

When locked, pressing any key (except ON/OFF, RUN/HOLD, MORE, MAIN, OPT, and B3) will cause the lock-out symbol (Table 2-1, page 2-45) to display along the left edge of the LCD and an error beep to sound.

- ❑ B4 SINGLE SWP ON/ OFF — Toggles the single sweep function on or off. When on, the **Site Master** will have to be manually triggered using the RUN/HOLD key on the keypad for each sweep.



- ❑ MORE — Selects the Option Sub-Menu, described below.

**Option Sub-Menu**

Provides for selecting additional **Site Master** options.

Choosing MORE causes the soft keys, below, to be displayed and the corresponding values to be shown in the message area.

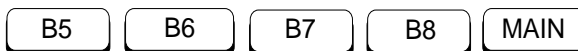

- ❑ B5 UNITS — Toggles between ENGLISH and METRIC units.
- ❑ B6 FIXED CW — Toggles the fixed CW function on or off. When on, if F1 is set equal to F2, a CW frequency is fixed at the selected value. When off, a narrow band of frequencies, centered on the selected frequency, is generated.
- ❑ B7 PRINTER — Displays a menu of supported printers—None, Seiko DPU-411, and HP Deskjet 340. Use the up/down arrow key and ENTER key to make the selection.
- ❑ B8 CONTRAST — Enables adjustment of the LCD contrast. Use the up/down arrow key and ENTER key to set the contrast.
- ❑ MAIN — Returns to the Main Menu.



**Power  
Menu**

Provides for setting power monitor modes and parameters.

Choosing POWER causes the soft keys, below, to be displayed and the corresponding values to be shown in the message area.



- ❑ UNITS — Toggles between dBm and Watts.
- ❑ REL — Turns relative mode OFF, if currently ON. If relative mode is currently OFF, turns it ON and causes the power level to be measured and saved as the base level. Subsequent measurements are then displayed relative to this saved value. With units of dBm, relative mode displays dB<sub>r</sub>; with units of Watts, relative mode displays % (percent).
- ❑ OFFSET — Turns Offset OFF, if currently ON. If Offset is currently OFF, turns it ON and opens the Offset parameter for data entry. Press ENTER when data entry is complete. Offset is the attenuation (in dB) inserted in the line between the DUT and the RF detector. The attenuation is added to the measured input level prior to display.
- ❑ ZERO — Turns Zero OFF, if currently ON. If Zero is currently OFF, turns it ON and initiates collection of a series of power level samples, which are averaged and saved. This saved value is



then subtracted from subsequent measurements prior to display.

- MAIN — Returns to the Main Menu.

## Remote Operation

All **Site Master** functions, settings, and operating modes (except for power on/off) are controllable using commands sent from an external computer via the serial port. A detailed description of the programming commands is available in the Site Master Programming Manual, P/N 10580-00012.

## Operating Procedures

**Site Master** operation can be divided into four functional areas: common functions, frequency domain, distance domain, and power monitor.

- Common functions are options and scale functions that are common to both frequency- and distance-domain measurements.
- Frequency domain measurements consist of Return Loss (RL), Standing Wave Ratio (SWR), and Cable Loss (CL) made over a selectable frequency range. RL and SWR characterize the magnitude of reflections present in a device or transmission line. CL measurements display the insertion loss of a transmission line over frequency.
- Distance domain measurements—commonly known as distance-to-fault (DTF)—are made over a selectable distance range. They include RL or SWR, but they also return informa-

tion that can help locate discontinuities in a transmission line. CL cannot be measured in the distance domain.

- Power monitor measurements can be either absolute or relative to some base power level, and can be displayed in either dBm or Watts. To allow measurement and display of power levels above the unit's specified input, the user may attenuate the signal and enter the corresponding offset. The offset is added to the measured input power prior to display. Finally, a zero adjust function is provided to allow subtraction of an inherent "noise" level prior to display.

**CAUTION:** *The measurement system MUST be calibrated at the ambient temperature prior to making a measurement. You must calibrate when the setup frequency is changed. The instrument can store up to two calibrations. These stored calibrations are independent of any stored setups. When you recall a stored setup, perform a new calibration or recall a stored calibration.*



## **Making Common Function Selections**

Common functions are options and scale functions that are common to both frequency- and distance-domain measurements.

### **Applying Power**

- Step 1.** Turn the **Site Master** on using the ON/OFF key.

- Step 2.** Observe that the **Site Master** opening screen appears and that it performs a self test. The firmware version and model number are shown in the opening screen.

### **Setting Options**

- Step 3.** Press the **OPT** soft key, from the Main Menu (page 2-8).
- Step 4.** Accept or change the settings of the **B1** through **B8** options. Refer to pages 2-17 and 2-18 for a description of each option.



### **Setting Scale/Limits**

- Step 5.** Press the **SCALE** soft key, from the Main Menu.
- Step 6.** Accept or change the settings. To change, press the applicable **TOP**, **BOTTOM**, or **LIMIT** soft key and either:
- Enter a numeric value from the keypad and press the **ENTER** key.
  - Or press the Up/Down Arrow key and press the **ENTER** key.

### Determining Remaining Battery Life

A symbol that denotes the charge state of the battery is continuously displayed in the top-right corner of the display (Figure 2-8). A totally black bar indicates a fully charged battery.

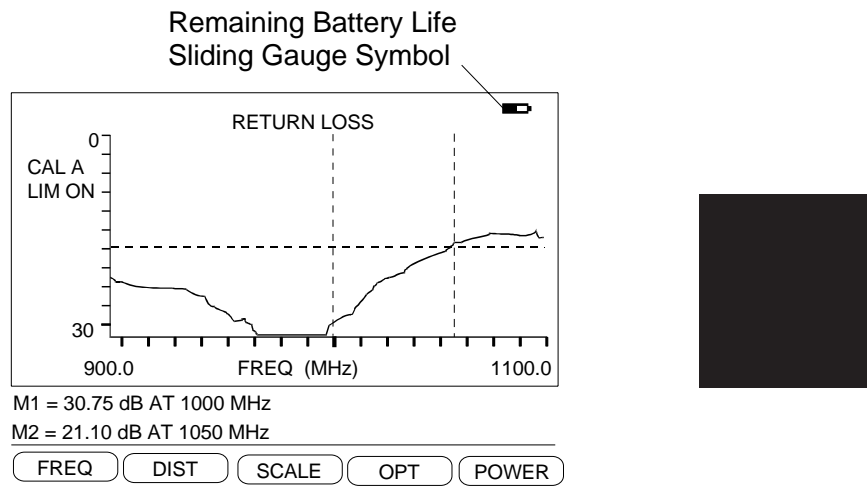



Figure 2-8. Battery Monitor

## **Making Frequency-Domain Measurements**

Frequency domain measurements consist of Return Loss (RL), Standing Wave Ratio (SWR), or Cable Loss (CL) measurements made over a selectable frequency range.

### **Return Loss or SWR Measurement**

#### **Selecting a Frequency Range**

- 
- Step 1.** Press the **FREQ** soft key, from the Main Menu (page 2-8).
  - Step 2.** Press the **F1** soft key from the Frequency Menu (page 2-9).
  - Step 3.** Enter the desired numerical value using the keypad or the Up/Down Arrow key (Figure 2-1, page 2-0). Press **ENTER** when data entry is complete.
  - Step 4.** Press the **F2** soft key.
  - Step 5.** Enter the desired numerical value using the keypad or the Up/Down Arrow key. Press **ENTER** when data entry is complete.
  - Step 6.** Check that the **FREQ (MHz)** scale in the display area indicates the new frequency start and stop values.

#### **Performing a Calibration**

- Step 7.** Perform a measurement calibration, using the **START CAL** key. Select **CAL A** or **CAL B**. Follow the ensuing “Connect **OPEN**, Press **ENTER**,” “Connect **SHORT**, Press **ENTER**,” and



“Connect LOAD, Press ENTER” instructions that appear in the message area. Connect the respective Open, Short, and Load component to the end of the Test Port Extension Cable (Figure 2-9) prior to pressing ENTER.

After each selection, one of the messages “Measuring OPEN,” “Measuring SHORT,” or “Measuring LOAD” appears while the measurement is in progress.

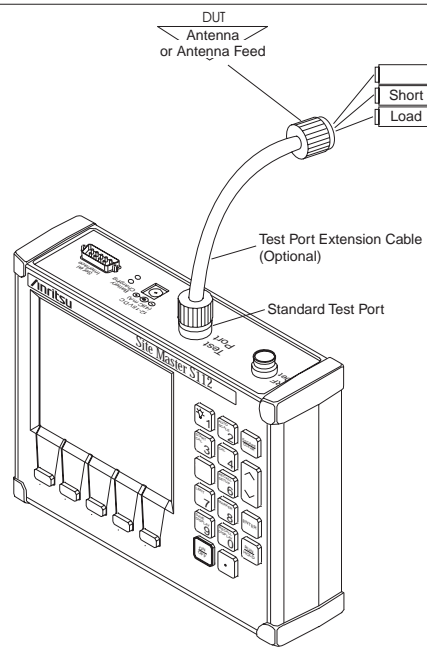

*Figure 2-9. Measurement/Calibration Test Setup*

## Chapter 2 Operation

---

*If, during a calibration, you wish to repeat a measurement or change the order in which the Open, Short, and Load are connected, press Up/Down Arrow key.*

### NOTES:

*For best calibration results — compensation for all measurement system uncertainties — ensure that the Open/Short/Load is at the end of the test port or optional extension cable; that is, at the same point that you will connect the antenna or device to be tested.*

*For best results, use a phase stable Test Port Extension Cable (see Optional Accessories). If you use a typical laboratory cable to extend the **Site Master** test port to the device-under-test, cable bending subsequent to the Open/ Short/Load calibration will cause uncompensated phase reflections inside the cable. Thus, cables which are NOT phase stable may cause measurement errors that are more pronounced as the test frequency increases.*

*For optimum calibration, ANRITSU recommends using precision calibration components.*

## Making a Measurement

- Step 8.** Connect the device-under-test to the **Site Master** Test Port or the Test Port Extension Cable.
- Step 9.** Observe the displayed waveform.

## **Scaling the Display**

- Step 10.** The display can be scaled using either of the following methods:
- ❑ Automatically scale the display using the **AUTO SCALE** key (Figure 2-1, page 2-0).
  - ❑ Manually scale the display using the **SCALE** soft key—from the Main Menu—and the **TOP** and **BOTTOM** soft keys from the ensuing soft key menu (page 2-16).

## **Adjusting Markers**

- Step 11.** Press the **MARKER** key (Figure 2-1, page 2-0) to call up the Marker Menu.
- Step 12.** If M1 needs to be turned OFF, press the **M1** soft key on the Markers Menu. If M1 needs to be turned ON, press the **M1** soft key again. This will open the M1 parameter for entry. If needed, enter the desired numerical value using the keypad or the Up/Down Arrow key (Figure 2-1, page 2-0). Press **ENTER** when the data entry is complete.
- Step 13.** If M2 needs to be turned OFF, press the **M2** soft key on the Markers Menu. If M2 needs to be turned ON, press the **M2** soft key again. This will open the M2 parameter for entry. If needed, enter the desired numerical value using the keypad or the Up/Down Arrow key (Figure 2-1, page 2-0). Press **ENTER** when the data entry is complete.
- Step 14.** Press the **MAIN** soft key to return to the Main Menu.



## **Adjusting a Limit**

- 
- Step 15.** Press the **LIMIT** key (Figure 2-1, page 2-0) to call up the Scale Menu.
  - Step 16.** If the Limit needs to be turned OFF, press the **LIMIT** soft key on the Scale Menu. If the Limit needs to be turned ON, press the **LIMIT** soft key again. This will open the Limit parameter for entry. If needed, enter the desired numerical value using the keypad or the Up/Down Arrow key (Figure 2-1, page 2-0). Press **ENTER** when the data entry is complete.
  - Step 17.** If you wish to have an audible beep when the trace is above the limit line, press the **OPT** soft key from the Main Menu (page 2-8).
  - Step 18.** Press the **B2** soft key from the Option Menu (page 2-17) to toggle the limit beep indicator ON.

## **Saving a Setup**

- Step 19.** Press the **SAVE SETUP** key (Figure 2-1, page 2-0).
- Step 20.** Enter the desired numerical value using the keypad (1 to 9) or the Up/Down Arrow key. Press **ENTER** when data entry is complete.

## **Recalling a Setup**

- Step 21.** Press the **RECALL SETUP** key.
- Step 22.** Enter the desired numerical value using the keypad (1 to 9) or the Up/Down Arrow key. Press **ENTER**

when data entry is complete. To restore the factory defaults, enter 0, then press ENTER.

### **Storing a Display**

- Step 23.** Press the SAVE DISPLAY key.
- Step 24.** Enter the desired numerical value using the keypad (1 to 40) or the Up/Down Arrow key. Press ENTER when data entry is complete.

### **Recalling a Display**

- Step 25.** Press the RECALL DISPLAY key.
- Step 26.** Enter the desired numerical value using the keypad (1 to 40) or the Up/Down Arrow key. Press ENTER when data entry is complete.



## **Cable Loss Measurement**

### **Selecting a Frequency Range**

- 
- Step 1.** Press the **FREQ** soft key, from the Main Menu (page 2-8).
  - Step 2.** Press the **F1** soft key from the Frequency Menu (page 2-9).
  - Step 3.** Enter the desired numerical value using the keypad or the Up/Down Arrow key (Figure 2-1, page 2-0). Press **ENTER** when data entry is complete.
  - Step 4.** Press the **F2** soft key.
  - Step 5.** Enter the desired numerical value using the keypad or the Up/Down Arrow key. Press **ENTER** when data entry is complete.
  - Step 6.** Check that the **FREQ (MHz)** scale in the display area indicates the new frequency start and stop values.

### **Performing a Calibration**

- Step 7.** Perform a measurement calibration, using the **START CAL** key. Select **CAL A** or **CAL B**. Follow the ensuing “Connect OPEN, Press ENTER,” “Connect SHORT, Press ENTER,” and “Connect LOAD, Press ENTER” instructions that appear in the message area. Connect the respective Open, Short, and Load component to the end of the Test Port Extension Cable (Figure 2-9, page 2-25) prior to pressing **ENTER**.

After each selection, one of the messages “Measuring OPEN,” “Measuring SHORT,” or “Measuring LOAD” appears while the measurement is in progress.

*If, during a calibration, you wish to repeat a measurement or change the order in which the Open, Short, and Load are connected, press Up/Down Arrow key.*

**NOTES:**

*For best calibration results — compensation for all measurement system uncertainties — ensure that the Open/Short/Load is at the end of the test port or optional extension cable; that is, at the same point that you will connect the antenna or device to be tested.*

*For best results, use a phase stable Test Port Extension Cable (see Optional Accessories). If you use a typical laboratory cable to extend the Site Master test port to the device-under-test, cable bending subsequent to the Open/ Short/Load calibration will cause uncompensated phase reflections inside the cable. Thus, cables which are NOT phase stable may cause measurement errors that are more pronounced as the test frequency increases.*

*For optimum calibration, ANRITSU recommends using precision calibration components.*



## Making a Measurement

- Step 8.** Connect the cable to be tested to the **Site Master** Test Port or the end of the Test Port Extension Cable (if used).
- Step 9.** Place an Open or Short at the other end of the cable.
- Step 10.** Observe the displayed cable loss vs frequency.

## Scaling the Display

- Step 11.** The display can be scaled using either of the following methods:
  - Automatically scale the display using the **AUTO SCALE** key (Figure 2-1, page 2-0).
  - Manually scale the display using the **SCALE** soft key—from the Main Menu—and the **TOP** and **BOTTOM** soft keys from the ensuing soft key menu (page 2-16).

## Adjusting Markers

- Step 12.** Press the **MARKER** key (Figure 2-1, page 2-0) to call up the Marker Menu.
- Step 13.** If M1 needs to be turned OFF, press the **M1** soft key on the Markers Menu. If M1 needs to be turned ON, press the **M1** soft key again. This will open the M1 parameter for entry. If needed, enter the desired numerical value using the keypad or the Up/Down Arrow key (Figure 2-1, page 2-0). Press **ENTER** when the data entry is complete.



- Step 14.** If M2 needs to be turned OFF, press the **M2** soft key on the Markers Menu. If M2 needs to be turned ON, press the **M2** soft key again. This will open the M2 parameter for entry. If needed, enter the desired numerical value using the keypad or the Up/Down Arrow key (Figure 2-1, page 2-0). Press ENTER when the data entry is complete.
- Step 15.** Press the **MAIN** soft key to return to the Main Menu.

### **Adjusting a Limit**

- Step 16.** Press the **LIMIT** key (Figure 2-1, page 2-0) to call up the Scale Menu.
- Step 17.** If the Limit needs to be turned OFF, press the **LIMIT** soft key on the Scale Menu. If the Limit needs to be turned ON, press the **LIMIT** soft key again. This will open the Limit parameter for entry. If needed, enter the desired numerical value using the keypad or the Up/Down Arrow key (Figure 2-1, page 2-0). Press ENTER when the data entry is complete.
- Step 18.** If you wish to have an audible beep when the trace is above the limit line, press the **OPT** soft key from the Main Menu (page 2-8).
- Step 19.** Press the **B2** soft key from the Option Menu (page 2-17) to toggle the limit beep indicator ON.



### **Saving a Setup**

- Step 20.** Press the **SAVE SETUP** key (Figure 2-1, page 2-0).

- Step 21.** Enter the desired numerical value using the keypad (1 to 9) or the Up/Down Arrow key. Press **ENTER** when data entry is complete.

### **Recalling a Setup**

- Step 22.** Press the **RECALL SETUP** key.
- Step 23.** Enter the desired numerical value using the keypad (1 to 9) or the Up/Down Arrow key. Press **ENTER** when data entry is complete. To restore the factory defaults, enter 0, then press **ENTER**.

### **Storing a Display**

- Step 24.** Press the **SAVE DISPLAY** key.
- Step 25.** Enter the desired numerical value using the keypad (1 to 40) or the Up/Down Arrow key. Press **ENTER** when data entry is complete.

### **Recalling a Display**

- Step 26.** Press the **RECALL DISPLAY** key.
- Step 27.** Enter the desired numerical value using the keypad (1 to 40) or the Up/Down Arrow key. Press **ENTER** when data entry is complete.

## Making Distance-Domain Measurements

Distance domain measurements—commonly known as distance-to-fault (DTF)—are made over a selectable distance range. They return information that can help locate discontinuities in a transmission line.

### Selecting a Frequency Range

**NOTE:**

*The maximum distance range is determined by the frequency span, number of data points, and relative propagation velocity:*

$$\text{Maximum Unaliased Range} = \frac{(15 \times 10^8) (129) (V_f)}{F2 - F1}$$

Where: *F1 is start frequency*

*F2 is stop frequency*

*V<sub>f</sub> is relative propagation velocity*

*maximum unaliased range is in meters.*

*Refer to Figure 2-10, page 2-36, for a plot of maximum distance range versus frequency span.*

- Step 1.** Press the **FREQ** soft key, from the Main Menu (page 2-8).
- Step 2.** Press the **F1** soft key from the ensuing soft key menu.
- Step 3.** Enter the desired numerical value using the keypad or the Up/Down Arrow key (Figure 2-1, page 2-0). Press **ENTER** when data entry is complete.
- Step 4.** Press the **F2** soft key.

**Chapter 2 Operation**

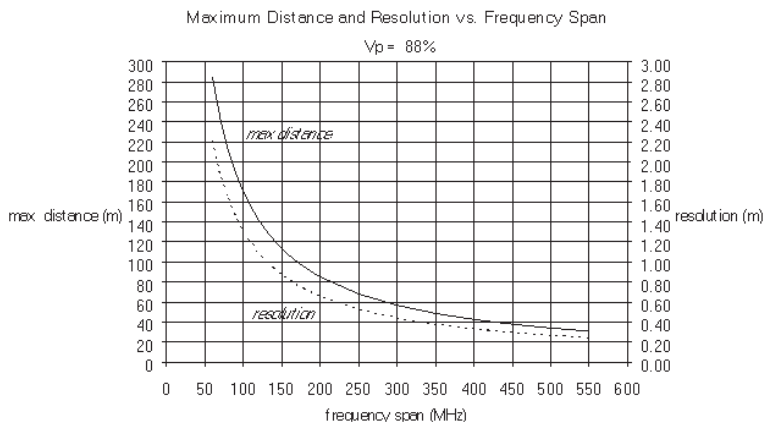
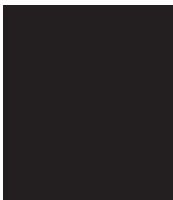
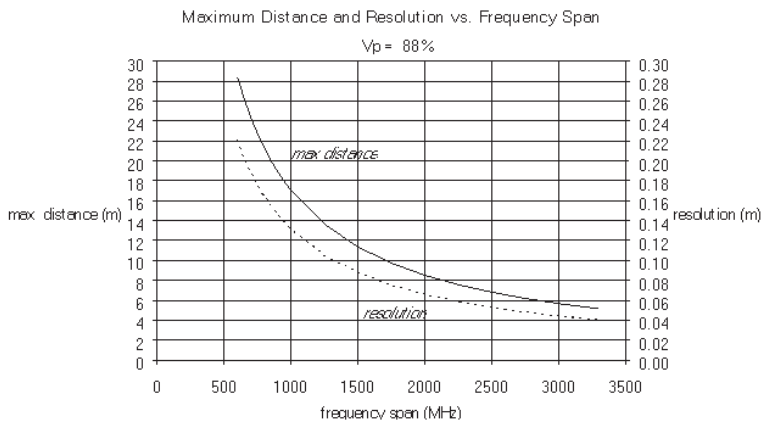

Figure 2-10. Maximum Distance and Resolution vs Frequency Span

- Step 5.** Enter the desired numerical value using the keypad or the Up/Down Arrow key. Press ENTER when data entry is complete.
- Step 6.** Check that the FREQ (MHz) scale in the display area indicates the new frequency start and stop values.

### **Performing a Calibration**

- Step 7.** Perform a measurement calibration, using the START CAL key. Select CAL A or CAL B. Follow the ensuing “Connect OPEN, Press ENTER,” “Connect SHORT, Press ENTER,” and “Connect LOAD, Press ENTER” instructions that appear in the message area. Connect the respective Open, Short, and Load component to the end of the Test Port Extension Cable (Figure 2-9, page 2-25) prior to pressing ENTER.

After each selection, one of the messages “Measuring OPEN,” “Measuring SHORT,” and “Measuring LOAD” appears while the measurement is in progress.

*If, during a calibration, you wish to repeat a measurement or change the order in which the Open, Short, and Load are connected, press Up/Down arrow key.*



**NOTES:**

*For best calibration results — compensation for all measurement system uncertainties — ensure that the Open/Short/Load is at the end of the test port or optional extension cable; that is, at the same point that you will connect the antenna or device to be tested.*

*For best results, use a phase stable Test Port Extension Cable (see Optional Accessories). If you use a typical laboratory cable to extend the **Site Master** test port to the device-under-test, cable bending subsequent to the Open/ Short/Load calibration will cause uncompensated phase reflections inside the cable. Thus, cables which are **NOT** phase stable may cause measurement errors that are more pronounced as the test frequency increases.*

*For optimum calibration, ANRITSU recommends using precision calibration components.*

## **Performing aDTF Measurement**

- Step 8.** Press the **DIST** soft key, from the Main Menu (page 2-8).
- Step 9.** Press the **D1** soft key from the ensuing soft key menu (page 2-11).
- Step 10.** Enter the desired numerical value using the keypad or the Up/Down Arrow key (Figure 2-1, page 2-0). Press **ENTER** when data entry is complete.
- Step 11.** Repeat the above two steps for **D2**.

- Step 12.** Press the **MKRS** soft key to go to the Markers Menu (page 2-10).
- Step 13.** Press the **M1** soft key.
- Step 14.** Enter the desired numerical value using the keypad or the Up/Down Arrow key. Press ENTER when data entry is complete.
- Step 15.** Repeat the above two steps for **M2**.
- Step 16.** Press the **MAIN** soft key to return to the Main Menu.
- Step 17.** Press the **DIST** soft key to go to the Distance Menu.
- Step 18.** Press the **MORE** soft key to go to the Distance Sub-Menu.
- Step 19.** Press the **CABLE** soft key to select a coaxial cable from the menu *or* press the **LOSS** and **PROP V** soft keys to enter cable loss and relative propagation velocity parameters manually (page 2-12). The loss of the cable shown in the cable menu is @ 1000 MHz.
- Step 20.** Enter the desired numerical values using the keypad or the Up/Down Arrow key. Press ENTER when data entry is complete.
- Step 21.** Press the **MAIN** soft key to return to the Main Menu.
- Step 22.** After calculations are complete (approximately 8 seconds), observe that the message area displays the return loss data at the two marker points.



**NOTES:**

*Press the **B5** soft key from the Option Sub-Menu (page 2-18) to toggle between feet and meters. Values entered in either will freely convert to the other.*

*Loss and relative propagation velocity values for many common cable types are listed in the table on the inside of the manual back cover.*

## **Making Power Measurements**

Power measurement is accomplished using a broadband (1 MHz to 3 GHz) RF detector, P/N 5400-71N50. The power monitor displays the measured power in dBm or Watts.

### **Entering Power Monitor Mode**

- Step 1.** Press the **POWER** soft key, from the Main Menu (page 2-8)

### **Zeroing the Power Monitor**

- Step 2.** With no power applied to the DUT, press the **ZERO** soft key from the Power menu (page 2-19). Wait a few seconds while the **Site Master** accumulates samples of the quiescent power level. When complete, ZERO ADJ: ON is displayed in the message area.



### **Measuring High Input Power Levels**

- Step 3.** Insert an attenuator between the DUT and the RF detector, sufficient to insure that the input power to the **Site Master** is no greater than 20 dBm.
- Step 4.** Press the **OFFSET** soft key.
- Step 5.** Enter the attenuation in dB using the keypad. Press **ENTER** to complete the entry. The message area will show **OFFSET is ON** along with the entered value in dB.

### **Displaying Power in dBm and Watts**

- Step 6.** Press the **UNITS** soft key to display power in Watts.

### **Displaying Relative Power**

- Step 7.** With the desired base power level input to the **Site Master**, press the **REL** soft key. The message area will show **REL: ON** and the power reading will indicate 100%.
- Step 8.** Press the **UNITS** soft key to display power in dBm. Since **REL** is **ON**, the power reading will be in dBm, relative to the base power level.



## Printing

Printing is accomplished with either of two printers: the Seiko DPU-411 thermal printer or the Hewlett Packard DeskJet 340 ink jet printer. Figure 2-11 shows a setup diagram for these two printers.

### Printer Switch Settings

Set the switches, SW1 and SW2, on the Seiko DPU-411 thermal printer as follows:

<u>Switch</u>	<u>1</u>	<u>2</u>	<u>3</u>	<u>4</u>	<u>5</u>	<u>6</u>	<u>7</u>	<u>8</u>
SW1	OFF	ON	ON	ON	ON	OFF	ON	ON
SW2	ON	ON	ON	OFF	OFF	OFF		

Set the switches on the serial-to-parallel interface cable to the HP Desk-jet 340 ink jet printer as follows:

<u>SW1</u>	<u>SW2</u>	<u>SW3</u>	<u>SW4</u>	<u>SW5</u>	<u>SW6</u>	<u>SW7</u>	<u>SW8</u>
OFF	ON	OFF	OFF	OFF	OFF	OFF	OFF

## Printing a Screen

- Step 1.** Connect the printer as shown in Figure 2-11.
- Step 2.** Obtain a SWR, RL, CL, or Distance-to-Fault measurement display.
- Step 3.** Select the printer using the **B7** soft key from the Option Sub-Menu (page 2-18).
- Step 4.** Press the PRINT key (Figure 2-1, page 2-0).

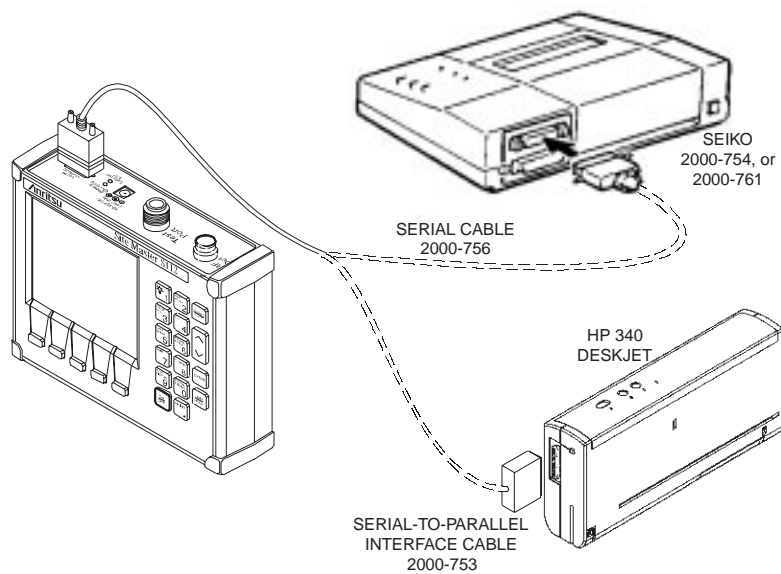

Figure 2-11. Printer Setup

## **Symbols**

Table 2-1 provides a listing of the symbols used as condition indicators on the LCD display.

## **Self Test**

At turn-on, the **Site Master** runs through a series of quick checks to ensure the system is functioning properly. Note that the battery voltage and temperature are displayed in the lower left corner below the self test message. If the battery is low, or if the ambient temperature is not within the specified operational range, Self Test will fail. If Self Test fails AND the battery is fully charged AND the **Site Master** is within the specified operating range, call your ANRITSU Service Center.



## **Error Codes**

### **Self Test Errors**

A listing of Self Test Error messages is given in Table 2-2.

### **Range Errors**

A listing of Range Error messages is given in Table 2-3.

## **Replacing the Battery**

Replacing the battery is the only recommended field-level maintenance action. If your battery fails, contact your ANRITSU Sales Office or Service Center. Table 2-4 provides a listing of current service centers.

Table 2-2. LCD Symbols

<u>Icon</u>	<u>Symbol</u>
	<b>Site Master</b> is in Hold or Power Conservation mode. To resume sweeping, press the RUN/HOLD key. After 10 minutes without a key press, the <b>Site Master</b> will automatically enter into its power conservation mode.
	<b>Site Master</b> is in keypad lockout mode. To turn off keypad lockout, use the <b>B3</b> soft key (page 2-17).
	Lock fail indication. Check battery. (If <b>Site Master</b> fails to lock with a fully charged battery, call your ANRITSU Service Center.)
	Processor timeout failure. Symbol appears at the frequency that causes an input RF overload; it then disappears as the sweep continues past that point.
	When calibration is performed, the <b>Site Master</b> stores the ambient temperature. If the temperature drifts outside the specified range, this indicator will flash. A recalibration at the current temperature is recommended.
	Indicates the remaining charge on the battery. The inner white rectangle grows longer as the battery charge depletes.



## Chapter 2 Operation

---

Table 2-3. Self Test Error Messages

<u>Error Message</u>	<u>Description</u>
BATTERY LOW	Battery voltage is less than 12.5 volts. Charge battery. <i>If condition persists, call your ANRITSU Service Center.</i>
EXTERNAL POWER LOW	External supply voltage is less than 12.5 volts. <i>Call your ANRITSU Service Center</i>
PLL FAILED	Phase-locked loops failed to lock. Charge battery. <i>If condition persists with a fully charged battery, call your ANRITSU Service Center</i>
INTEGRATOR FAILED	Integration circuit could not charge to a valid level. Charge battery. <i>If condition persists with a fully charged battery, call your ANRITSU Service Center.</i>
EEPROM R/W FAILED	Non-volatile memory system has failed. <i>Call your ANRITSU Service Center.</i>
OUT OF TEMP. RANGE	Ambient temperature is not within the specified operating range. Return temperature to specified operating range. <i>If condition persists, call your ANRITSU Service Center.</i>

*Note: A listing of current ANRITSU service centers is given in Table 2-4.*

---

Table 2-4. Range Error Messages (1 of 2)

Error Message	Description
RANGE ERROR:F1 > F2	The start (F1) frequency is greater than the stop (F2) frequency.
RANGE ERROR:D1 > D2	The start (D1) distance is greater than the stop (D2) distance.
RANGE ERROR:D2 > DMax=xx.x ft (m)	<p>The stop distance (D2) exceeds the maximum unaliased range. This range is determined by the frequency span, number of points, and relative propagation velocity:</p> $\text{Maximum Unaliased Range} = \frac{(1.5 \times 10^8) (129) (V_f)}{F2 - F1}$ <p>Where: F1 is start frequency            F2 is stop frequency            V<sub>f</sub> is relative propagation velocity            maximum unaliased range is in meters</p> <p>Refer to Figure 2-10, page 2-35, for a plot of maximum range versus frequency span.</p>
RANGE ERROR: TOP<=BOTTOM	The SWR scale parameter top value is less than or equal to its bottom value.
RANGE ERROR: TOP>=BOTTOM	The RL scale parameter top value is greater than or equal to its bottom value.
CAL INCOMPLETE	A complete open, short, and load calibration must be performed before calibration can be turned on.
CAL VALID FROM: xxxx.x to xxxx.x MHz	The calibration was performed at a frequency range that is different from the current range.

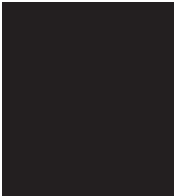

## Chapter 2 Operation

---

Table 2-3. Range Error Messages (2 of 2)

<u>Error Message</u>	<u>Description</u>
DIST REQUIRES F1 < F2	Valid distance to fault plots require a non-zero frequency span.
DIST REQUIRES CAL	Distance-to-fault measurements do not provide usable data with CAL OFF.
NO STORED SWEEP AT THIS LOCATION	Attempting to recall a display from a location that has not been previously written to. That is, the location does not contain stored sweep.
USE OPTIONS MENU TO SELECT A PRINTER	Attempting to print a display with no printer selected. Select a printer, then retry.
DISTANCE AND CABLE INSERTION LOSS MODE ARE INCOMPATIBLE	DTF measurements only display RL or SWR versus distance.
CANNOT ZERO NO DETECTOR INSTALLED	Attempting to perform a Power Monitor zero adjust function with no RF detector connected to the <b>Site Master</b> .
CANNOT ZERO INPUT SIGNAL TOO HIGH	Attempting to perform a Power Monitor zero adjust function with an input of greater than -20 dBm.
POWER MONITOR OPTION NOT INSTALLED	Attempting to enter Power Monitor mode with no option 5 installed.

---



## Using the Soft Carrying Case

The soft carrying case has been designed such that the strap can be un-snapped to allow the case to be easily oriented horizontally; thus allowing the **Site Master** controls to be more easily accessed (Figure 2-11).

---

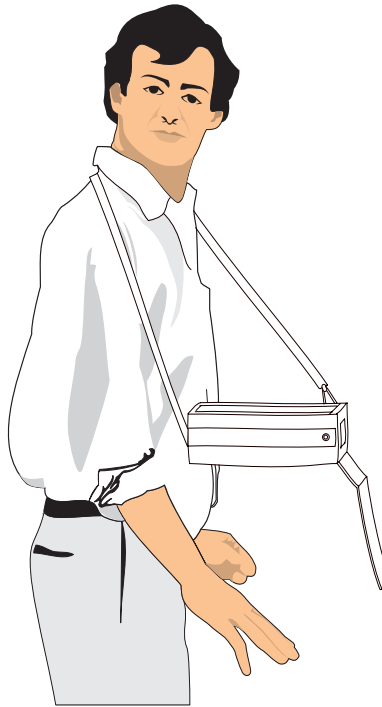

---

*Figure 2-11. Using Soft Carrying Case*

## ***Chapter 2 Operation***

---

*Table 2-4. ANRITSU Service Centers (1 of 2)*

---

### **UNITED STATES**

ANRITSU COMPANY  
685 Jarvis Drive  
Morgan Hill, CA 95037-2809  
Telephone: (408) 776-8300  
FAX: 408-776-1744

ANRITSU COMPANY  
10 Kingsbridge Road  
Fairfield, NJ 07004  
Telephone: (201) 227-8999  
FAX: 201-575-0092

### **AUSTRALIA**

ANRITSU PTY. LTD.  
Unit 3, 170 Foster Road  
Mt Waverley, VIC 3149  
Australia  
Telephone: 03-9558-8177  
Fax: 03-9558-8255

### **BRAZIL**

ANRITSU ELECTRONICA LTDA.  
Praia de Botafogo 440, Sala 2401  
CEP 22250-040, Rio de Janeiro, RJ, Brasil  
Telephone: 021-28-69-141  
Fax: 021-53-71-456

### **CANADA**

ANRITSU INSTRUMENTS LTD.  
215 Stafford Road, Unit 102  
Nepean, Ontario K2H 9C1  
Telephone: (613) 828-4090  
FAX: (613) 828-5400

### **CHINA**

ANRITSU BEIJING SERVICE CENTER  
Beijing Fortune Building  
416W, 5 Dong San Huan Bei Lu  
Chaoyang qu  
Beijing 100004, China  
Telephone: 010-501-7559  
FAX: 010-501-7558

### **FRANCE**

ANRITSU S.A.  
9 Avenue du Quebec  
Zone de Courtaboeuf  
91951 Les Ulis Cedex  
Telephone: 016-44-66-546  
FAX: 016-44-61-065

### **GERMANY**

ANRITSU GmbH  
Grafenberger Allee 54-56  
D-40237 Dusseldorf  
Germany  
Telephone: 0211-67 97 60  
FAX: 0211-68 33 53

### **INDIA**

MEERA AGENCIES (P) LTD  
A-23 Hauz Khas  
New Delhi 110 016  
Telephone: 011-685-3959  
FAX: 011-686-6720

---

*Table 2-4. ANRITSU Service Centers (2 of 2)*

**ISRAEL**

TECH-CENT, LTD  
Haarad St. No. 7, Ramat Haahayal  
Tel-Aviv 69701  
Telephone: (03) 64-78-563  
FAX: (03) 64-78-334

**ITALY**

ANRITSU Sp.A  
Rome Office  
Via E. Vittorini, 129  
00144 Roma EUR  
Telephone: (06) 50-22-666  
FAX: (06) 50-22-4252

**JAPAN**

ANRITSU CORPORATION  
1800 Onna Atsugi-shi  
Kanagawa-Prf. 243 Japan  
Telephone: 0462-23-1111  
FAX: 0462-25-8379

**KOREA**

ANRITSU KOREA (AWK)  
#Daeo Bldg. 26-5  
Yeoido Dong, Youngdeungpo  
Seoul Korea 150 010  
Telephone: 02-782-7156  
FAX: 02-782-4590

**SINGAPORE**

ANRITSU (SINGAPORE) PTE LTD  
3 Shenton Way #24-03  
Shenton House  
Singapore 0106  
Telephone: 2265206  
FAX: 2265207

**SOUTH AFRICA**

ETESCSA  
1st Floor Montrose Place  
Waterfall Park  
Becker Road  
MIDRAND  
SOUTH AFRICA  
Telephone: 011-315-1366  
Fax: 011-315-2175

**SWEDEN**

ANRITSU AB  
Box 247  
S-127 25 Skarholmen  
Telephone: (08) 74-05-840  
FAX: (08)71-09-960

**TAIWAN**

ANRITSU CO., LTD.  
8F, No. 96, Section 3  
Chien Kuo N. Road  
Taipei, Taiwan, R.O.C.  
Telephone: (02) 515-6050  
FAX: (02) 509-5519

**UNITED KINGDOM**

ANRITSU LTD.  
200 Capability Green  
Luton, Bedfordshire  
LU1 3LU, England  
Telephone: 015-82-41-88-53  
FAX: 015-82-31-303



# ***Chapter 3***

## ***Software Tools***

### ***Program***

#### **Description**

The **Site Master** Software Tools program provides the means for transferring the measured trace, along with any applied markers and/or a limit, to the screen of an MS-DOS based personal computer (PC) running Windows, Windows for Workgroups 3.xx, Windows NT, or Windows 95.

#### **Requirements**

The **Site Master** Software Tools program is a standard Windows 3.x program and will run on any computer that will run Windows, Windows for Workgroups 3.xx, Windows NT, or Windows 95. Typically, this means having a PC with the following characteristics:

- 386 or better microprocessor running enhanced mode (386DX, 33 MHz or better, recommended).
- 8 MBytes of memory, minimum.
- Hard Disk Drive, with approximately 3 MBytes of available space.



## Communication Port Setting

The **Site Master** Software Tools communicates with the **Site Master** through a standard COM port on the PC. It is important that your Windows COM port settings conform to the actual hardware settings. Table 3-1 provides a listing of standard COM port settings for most IBM AT-Compatible computers.

Table 3-1. Standard COM Port Settings

<u>Port</u>	<u>IRQ</u>	<u>Address</u>
COM1	4	3F8
COM2	3	2F8
COM3	4	3E8
COM4	3	2E8

Since various add-in devices such as sound cards, modems, and network cards use IRQ (Interrupts), it is possible that your computer has non-standard COM port settings. Please consult your computer vendor for COM port address and IRQ information.

### Changing COM Port Settings—Windows 3.1

Refer to Figure 3-1 while performing the following procedure.

- Step 1.** Open the **Windows Control Panel**.
- Step 2.** Double click on the **Ports** icon. The Ports dialog box appears.
- Step 3.** Click on the icon for the COM Port whose communications settings you wish to specify, then click the **Settings...** button. The Settings dialog box appears.

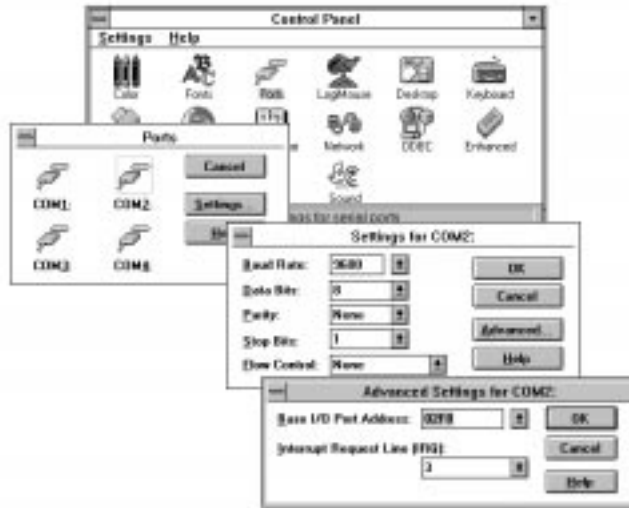

Figure 3-1. Windows 3.1 COM Port Setting Dialog Boxes

- Step 4.** Change to the following settings if necessary:
- Baud Rate: 9600
  - Data Bits: 8
  - Parity: None
  - Stop Bits: 1
  - Flow Control: None
- Step 5.** Click on the **Advanced...** button. At the Advanced Settings dialog box verify the COM Port Base Address and IRQ. Click **OK** when done.
- Step 6.** Click **OK** again and then **Close** to close the COM Port Setting Windows.



*Note:*  
If you changed the COM Port Base Address and/or IRQ, you will need to restart Windows.



Figure 3-2. Windows 95 COM Port Setting Dialog Boxes

### Changing COM Port Settings—Windows 95

Refer to Figure 3-2 while performing the following procedure.

- Step 1.** Open the **Windows Control Panel**.
- Step 2.** Double click on the **SYSTEM** icon. The System Properties window appears.
- Step 3.** Select **Device Manager**. The Device List appears.

### *Chapter 3 Screen Capture Program*

---

- Step 4.** Double click on the item **Ports (COM & LPT)** in the device list.
- Step 5.** Double click on the **Communications Port** you want to set. The Communications Port Properties window appears.

*NOTE:*  
*If Windows doesn't show any available COM Ports, consult your computer manufacturer.*

- Step 6.** Choose **Port Settings**, then change to the following settings if necessary.
- |               |      |
|---------------|------|
| Baud Rate:    | 9600 |
| Data Bits:    | 8    |
| Parity:       | None |
| Stop Bits:    | 1    |
| Flow Control: | None |
- Step 7.** Choose **Resource** and verify the COM Port Base Address and IRQ. Click **OK** when done.
- Step 8.** Click **OK** again to close the System Properties window.

*Note:*  
*If you changed the COM Port Base Address and/or IRQ, you will need to restart Windows.*



## Software Installation

The **Site Master** Software Tools program is a conventional Microsoft Windows 3.x program. Installation is similar to all other such programs. For users new to Windows 3.x, a detailed procedure is given below.

- Step 1.** Insert the Wiltron **Site Master** Software Tools For Windows disk in floppy drive A:\ or B:\.
- Step 2.** In the Windows Program Manager, pull down the File menu and select Run.
- Step 3.** Type A: (or B:)\SETUP, when the dialog box appears.
- Step 4.** Press the Enter key to select the default directory, C:\SITEMSTR, and begin the Setup routine.
- Step 5.** Select "OK" or press the Enter key to exit the Setup routine, when its completes.

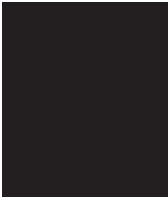

*NOTE: The Setup routine will create a new Program Manager Group named "Site Master Software Tools." This group will contain three file icons, "Read Me," "Site Master Help," and "Site Master Software Tools."*

- Step 6.** Double-click on the "Read Me" icon to read about (1) recent changes that did not get into this manual and/or (2) important features or problems that you should know about.

- Step 7.** Double-click on the “Site Master Help” icon to acquaint yourself with the comprehensive on-line manual. This manual provides descriptive narrative for the various program features and controls.
- Step 8.** Double-click on the “Site Master Software Tools ” icon to open the Software Tools program.

## Plot Capture

Plots (traces) can be captured either singly from the **Site Master** display or in multiples from one or more stored-display locations. Both methods are described below.

The recommended method is the **Capture Multiple Traces** option in the **Capture** pull-down menu. Using this method, you can download to the Software Tools program in one operation all of the data residing in the up-to-40 Stored Display memory locations. The downloaded traces will appear in cascade on the PC screen.

### Multiple trace capture (preferred method)

- Step 1.** Connect the supplied cable as shown in Figure 3-3.
- Step 2.** Open the “**Site Master Software Tools**” group, in the Windows Program Manager.  
*(Select the **Windows** pull-down menu from the Program Manager menu bar, and select **Site Master Software Tools**.)*
- Step 3.** Double-click on the “**Site Master Software Tools** ” icon to open the program.



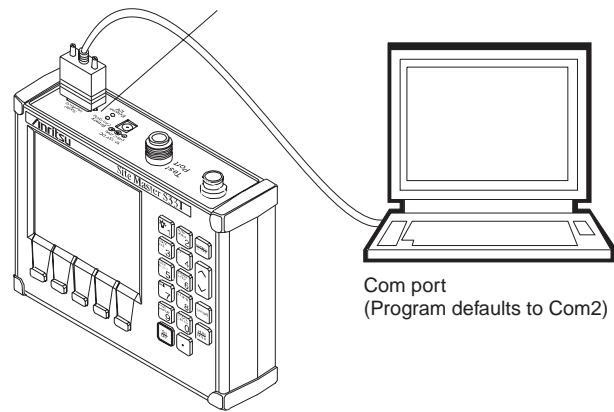
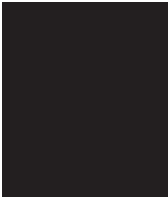

Figure 3-3. Equipment Setup for Site Master Tools Operation

- Step 4.** Click on **Capture**, in the top menu bar, and select **Capture Multiple Traces** from the drop-down menu.
- Step 5.** Enter the number (or numbers) of the stored-display memory location(s) (1 to 40) from which you wish to display traces in **Site Master Software Tools**.
- Step 6.** Select "OK."
- Step 7.** Observe that the "Acquiring Control" box appears on the screen, then disappears as the traces are automatically acquired.



## Single trace capture

- Step 1.** Perform steps 1, 2, and 3 of the multiple-trace-capture procedure.
- Step 2.** Click on **Capture**, in the top menu bar, and select **Start Capture** from the drop-down menu.
- Step 3.** Observe that a “Waiting for Data” box appears on the screen.
- Step 4.** On the **Site Master**,
- Capture a new trace and store it to a memory location.
  - Recall the stored plot to the screen.
  - Press the ENTER key (on the **Site Master**) to start the screen capture.

*NOTE: The ENTER key on the Site Master must be pressed while the PC screen shows “Waiting for Data” for the transfer of information to be complete.*

- Step 5.** On the PC, observe that the “Waiting for data” box disappears and the trace capture process begins. Within a short time, the **Site Master** trace will appear.
- Step 6.** If the trace differs from the Site Master display, it is being autoscaled by the capture program. To turn off autoscaling, proceed as follows:
- Click on the **Settings** menu, in the top menu bar.

- ❑ Click on **Default Plot Settings**, pull down menu.
- ❑ Click on **Per Site Master**, in the dialog box, and select **OK** to save changes.
- ❑ On the **Site Master**, *press the ENTER key to re-send the plot.*

## Program Operation

The captured trace on the PC can be scaled and have its limit line, markers, and properties changed. (Select **Plot Properties** under the **View** menu to make these changes.) The operation of the various menus that allow these operations to be accomplished is straightforward. To read about the operation of the menus, refer to the on-line help screens. They can be accessed from the **Help** menu, in the top menu bar.



## Fault Location Software

A captured RL or SWR trace can be transformed to a Distance to Fault display. This is useful for determining the location of faults, connections, and other discontinuities within the cable.

To transform a plot, select **Fault Find** from the **Tools** menu (or click the toolbar button). A drop down menu will appear that asks you to supply start and stop distances, along with dielectric constant or propagation velocity and insertion loss values. The table on the inside of the manual back cover provides these values for some of the more popular cables. The values are given at a nominal frequency of 1000 MHz. If values are needed at a different frequency, or if you need the exact values for more accurate measurement, please contact the cable manufacturer. Cables may be added to the list by editing the `cables.lst` file and following the existing format. The distance may be entered in feet or meters. Propagation velocity or dielectric constant may be used. The units may be changed by selecting **Default Plot Settings** under the **Settings** menu and changing “Distance Units” or “Cable Units.”

After supplying the needed information and clicking OK, a new plot will open showing cable match vs. distance.

## Smith Chart Software

After obtaining a frequency SWR or RL plot on the computer display, click the Smith Chart icon. Read the Help file to see how this feature functions (under Smith Chart and Data Readout).



## **Saving a Plot as a Windows Metafile**

Plots can be saved as Windows Metafiles (.WMF). The metafile may be imported into other graphic programs, but cannot be reloaded into the Site Master Software Tools program.

To save a plot as a Windows Metafile, click on **File**, in the top menu bar, and select **Save as Metafile** from the drop down menu.

## **Saving Data to a Spreadsheet**

The data points from a plot can be exported to a spreadsheet via the clipboard. To transfer data to a Windows spreadsheet program:

- Step 1.** Select **Clipboard Format** from the Settings menu and choose **Formatted Text**.
- Step 2.** Capture or load the desired plot.
- Step 3.** Copy the data to the clipboard by selecting **Copy** from the Edit menu.
- Step 4.** Open the spreadsheet program and place the cursor where the first data point should appear.
- Step 5.** Select **Paste** from the spreadsheet program's Edit menu.

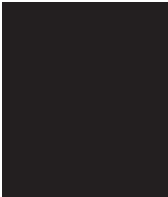

## “Drag-n-Drop”

**Site Master** Software Tools is Windows based. Graphs can “Drag-n-Drop” onto each other. **Site Master** Software Tools allows quick comparison of “before” and “after” Distance-To-Fault measurements. Recent data is compared to a historical PC database record, which is usually recorded during site installation/commissioning.

Each cable/antenna tends to have a unique Distance-To-Fault (DTF) “Signature” because differing cable electrical lengths, cable types, dielectric thickness variations, and the positions of components

(connectors, adapters, and lightning arrestors) will cause different reflections at differing positions in the transmission line. Variations in the “signature” between maintenance intervals offer a good indication of damage or damage causing conditions.

## Printing

Captured traces may be printed from a PC using **Site Master** Software Tools. Once a captured trace has been downloaded choose **Print** under the **File** menu for printing options. The printer setup can be altered, plots can be scaled, and multiple plots can be printed from the Print dialog box.





**NOTES**



Coaxial Cable Technical Data

Cable Type	Dialectric	Relative Propagation Velocity ( $v_r$ )	Dielectric Constant ( $\epsilon_r$ )	Nominal Atten. dB/m @ 1000 MHz
RG8, 8A,10,10A	P	0.659	2.303	0.262
RG9, 9A	P	0.659	2.303	0.289
RG14,14A	P	0.659	2.303	0.256
RG17, 17A	P	0.659	2.303	0.180
RG18A	P	0.659	2.303	0.144
RG19A	P	0.659	2.303	0.118
RG20A	P	0.659	2.303	0.118
RG21, 21A	P	0.659	2.303	1.411
RG29A	P	0.659	2.303	0.531
RG55,55A, 55B	P	0.659	2.303	0.541
RG58, 58B	P	0.659	2.303	1.574
RG58A, 58C	P	0.659	2.303	0.787
RG71, 71A, 71B	P	0.659	2.303	0.394
RG87A	T	0.840	1.417	0.249
RG94A, 115, 115A	T	0.710	1.984	0.230
RG117, 118	T	0.659	2.303	0.115
RG119, 120, 126	T	0.659	2.303	0.180
RG140	T	0.659	2.303	0.197
RG141	T	0.659	2.303	0.427
RG142	T	0.659	2.303	0.443
RG143	T	0.659	2.303	0.312
RG144	T	0.659	2.303	0.030
RG178B	T	0.659	2.303	1.509
RG179B	T	0.659	2.303	0.787
RG187, 188	T	0.659	2.303	1.017
RG214	P	0.660	2.296	0.292
RG223	P	0.659	2.303	0.165
FSJ1-50A	P	0.840	1.417	0.197
FSJ2-50	P	0.830	1.452	0.134
FSJ4-50B	P	0.810	1.524	0.119
LDF4-50A	P	0.880	1.291	0.077
LDF5-50A	P	0.890	1.262	0.043
LDF6-50	P	0.890	1.262	0.032
LDF7-50A	P	0.880	1.291	0.027
LDF12-50	P	0.880	1.291	0.022
FE25	T	0.760	1.731	0.150



**Anritsu**